

Data Sheet



Article number: 071091400280040

Description: Cardan drive shaft 0.109.140.001
S=280 X=40 Bore with keyway

Measures

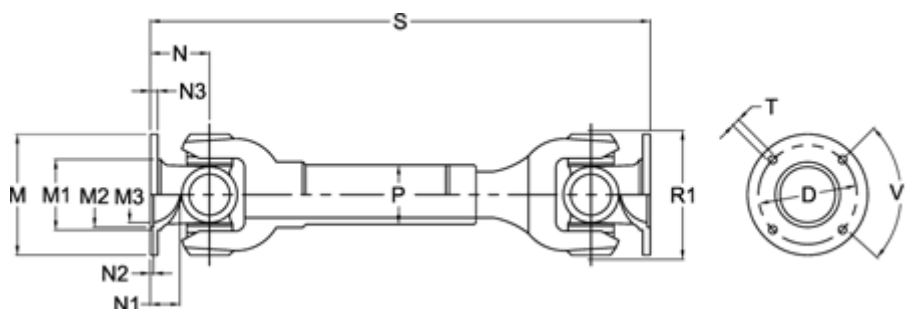

D	= 74,5 +-0,1	N1	= 18	T	= 8 B12
Extension X	= 40	N2	= 2,5 +0,3	V1 degrees	= 90
Flange diameter M	= 90	N3	= 6		
M1	= 56	Number og Flangeholes	= 4		
M2	= 47	P	= 50x2		
M3	= 39	R1	= 86		
Max. Bending Angle degrees	= 20	S min	= 280		
N	= 42	Spline dim. DIN 5480	= 32x2x14		